

35x35x10mm

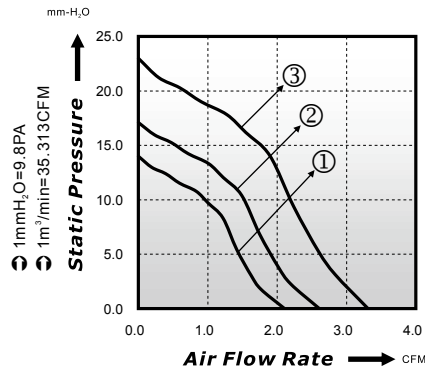

■ P-Q Curve (At Rated Voltage)



■ Dimensions Drawing

Unit: (mm)

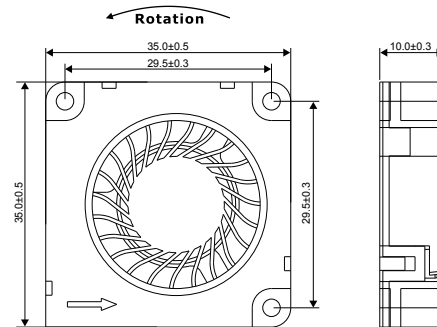

Model No	Bearing (*)	Rated Voltage (VDC)	Rated Current (A)	Power Consumption (Watts)	Speed (rpm)	Air Flow (CFM)	Static Pressure (mmH ₂ O)	Noise (dBA)	Curve
EBD03510-05L*	○ ● ⊖	5	0.29	1.45	8000	2.1	14.0	28.0	1
EBD03510-05M*	○ ● ⊖	5	0.35	1.75	10000	2.6	17.1	32.5	2
EBD03510-05H*	○ ● ⊖	5	0.46	2.30	13000	3.3	23.0	38.5	3
EBD03510-12L*	○ ● ⊖	12	0.12	1.44	8000	2.1	14.0	28.0	1
EBD03510-12M*	○ ● ⊖	12	0.145	1.74	10000	2.6	17.1	32.5	2
EBD03510-12H*	○ ● ⊖	12	0.19	2.28	13000	3.3	23.0	38.5	3

* Bearing Type: ○ Sleeve ● Two Ball ⊖ Hydro-Dynamic